

---

# Table of Contents

## E90 Driver Information Systems

Subject	Page
<b>Introduction</b> .....	<b>4</b>
<b>Instrument Cluster</b> .....	<b>5</b>
IPO .....	6
System Circuit Diagram .....	7
System Components .....	8
Display Areas .....	8
Speedometer / Tachometer .....	10
Instantaneous Fuel Economy Gauge .....	10
Fuel Gauge .....	10
Outside Temperature Display .....	10
Indicator and Warning Lamps .....	11
Liquid Crystal Display .....	11
Manipulation Dot .....	11
Program and Gear Display .....	11
Acoustic Generators .....	12
Backlighting .....	12
Audible Warnings .....	12
On-Board Computer .....	13
Display Variants .....	13
Show Displays .....	14
Principals of Operation .....	15
Moving Dial Indicator .....	15
Fuel Gauge .....	16
On-Board Computer .....	16
BC Main Menu .....	17
Service Information .....	20
Test Functions .....	20
To Start Function Test .....	20
Display of Test Functions .....	20
Locking and Unlocking the Test Functions .....	20
To End Test Function .....	20
Visual System Test .....	20
Overview of Test Functions .....	21
Component Replacement and Trial Replacement .....	22

---

<b>Subject</b>	<b>Page</b>
To Select Check Control Messages .....	.22
Selecting ID Code of Check Control Message .....	.22
Personal Profile .....	.51
Changing Unit of Measure .....	.52
<b>Central Information Display (CID) .....</b>	<b>.53</b>
IPO .....	.54
System Circuit Diagram .....	.55
System Components .....	.56
Central Information Display (CID) .....	.56
Liquid Crystal Display .....	.56
Controller .....	.57
Principles of Operation .....	.58
Service Information .....	.59
Service Mode .....	.59
Sources of Information .....	.59
Activating Service Mode .....	.59
<b>Connected Service .....</b>	<b>.60</b>
Condition Based Service (CBS) .....	.61
CBS Display- Instrument Cluster .....	.62
CBS Display - Central Information Display .....	.63
Service Information .....	.65
Resetting the Service Operations .....	.65
Entering Due Date .....	.65

---

# E90 Driver Information Systems

**Model: E90**

**Production: From Start of Production**

# OBJECTIVES

After completion of this module you will be able to:

- Understand the different display areas of the instrument cluster
- Understand the operation of the cluster
- Navigate through the CID screens effectively
- Understand Connected Service

# Introduction

The overall concept for the displays and control of the driver and comfort area was to design a more discrete and subtle appearance of the interior. Fewer switches and controls simplify operations in the new BMW 3 Series.

The display, indicator and control elements are arranged in order of importance: "Most important at the top - less important at the bottom."

There are four major systems that make up the displays and indicators for the E90:

- Instrument Cluster
- Central Information Display (CID)
- Personal Profile.
- Connected Service



**BMW 3 Series Display, Indicator and Control Concept**

Index	Explanation	Index	Explanation
1	Steering column stalk/steering wheel	8	Central Information Display (CID)
2	Instrument cluster	9	Controller

# Instrument Cluster

The new BMW 3 Series is equipped with an instrument cluster featuring analog instruments for:

- Speed
- Engine speed
- Economy control and
- Fuel level.

Two large pointer instruments show the road speed and engine speed. Two smaller pointer instruments display fuel level and current fuel consumption.

All of the indicator lamps are located in the center at the top between the two large instrument dials.

The liquid crystal display is located in the center between the two large pointer instruments.

A classic two-dial design draws attention to both instruments. Each finished unobtrusively with two trim rings in pearl-finish chrome.

The instrument cluster on the BMW3 Series has no gateway function. Only the outside temperature, the information from the steering column switch cluster, and footwell module are shown directly in the display.

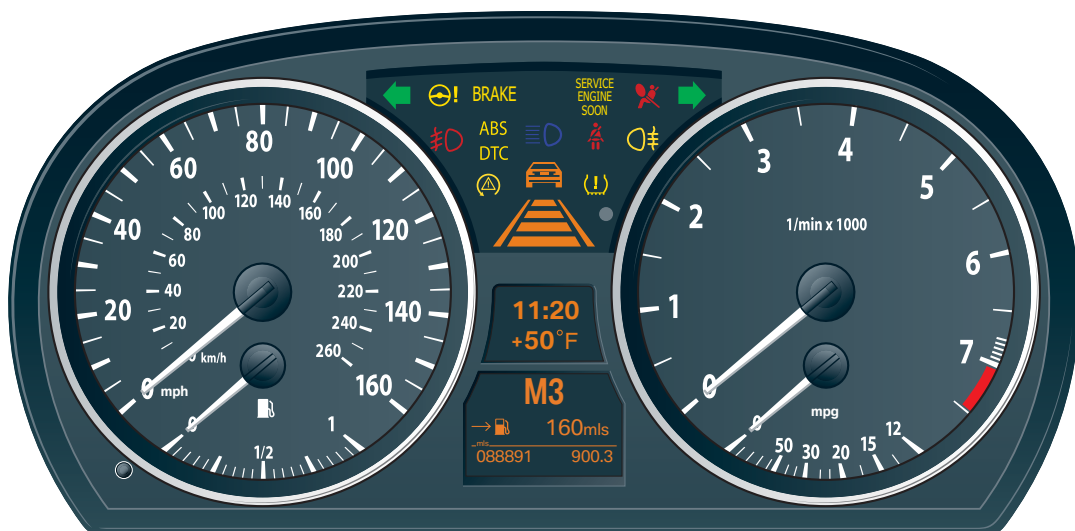

# IPO

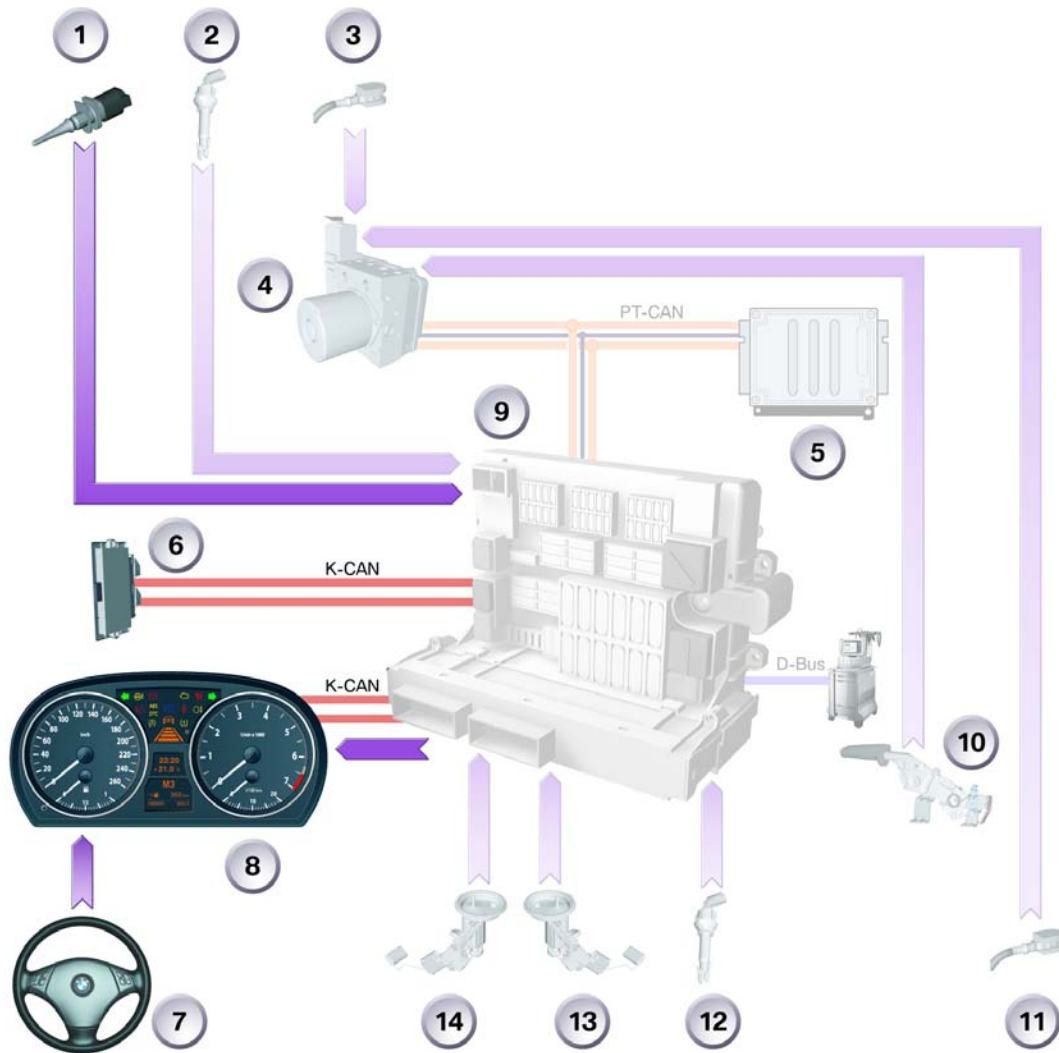

Index	Explanation	Index	Explanation
1	Outside temperature sensor	11	Brake pad wear sensor, rear right
2	Coolant level switch	12	Washer fluid level sensor
3	Brake pad wear sensor, front left	13	Fuel level sensor, right
4	Dynamic Stability Control (DSC)	14	Fuel level sensor, left
5	Digital Motor Electronics (DME)	PT-CAN	Powertrain control module
6	Footwell Module (FRM)	D-Bus	Diagnosis bus
7	Steering column switch center	K-CAN	Body Controller Area Network
8	Instrument cluster	KL30	Terminal 30
9	Junction box (JB)	KL31	Terminal 31
10	Contact switch, handbrake		

## System Circuit Diagram

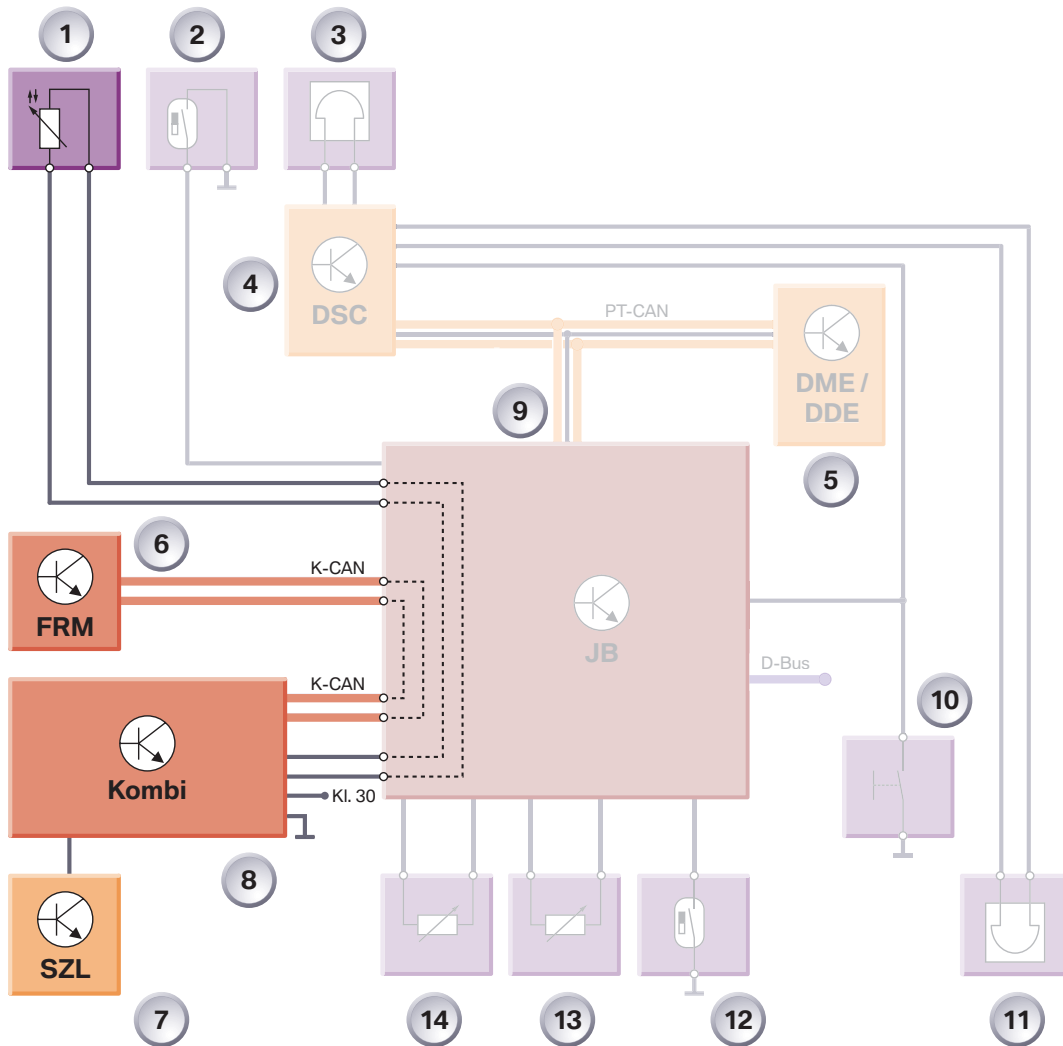

Index	Explanation	Index	Explanation
1	Outside temperature sensor	11	Brake pad wear sensor, rear right
2	Coolant level switch	12	Washer fluid level sensor
3	Brake pad wear sensor, front left	13	Fuel level sensor, right
4	Dynamic Stability Control (DSC)	14	Fuel level sensor, left
5	Digital Motor Electronics (DME)	PT-CAN	Powertrain control module
6	Footwell Module (FRM)	D-Bus	Diagnosis bus
7	Steering column switch center	K-CAN	Body Controller Area Network
8	Instrument cluster	KL30	Terminal 30
9	Junction box (JB)	KL31	Terminal 31
10	Contact switch, handbrake		

---

## System Components

The instrument cluster is secured by means of two torx-head tapping screws to the instrument panel. A shroud prevents reflections in the acutely angled windscreen.

The instrument cluster comprises the following components:

- Instrument dials
- Indicator and warning lamps
- Program and gear display for automatic transmission and sequential manual gearbox
- Acoustic generator for audible direction indicator signal and CC gong for Rad 2 (The audible signals are output via the radio speaker when equipped with a CID).
- Button for resetting trip distance recorder and selecting condition-based service in CBS menu. Press button for > 4 seconds to select the workshop menu. The settings are selected via the rocker switch in the steering column stalk.
- Other connected components which serve to activate the displays in the instrument cluster (see system overview/system circuit diagram).



## Display Areas

The instrument cluster features display areas for:

- Speedometer
- Tachometer
- Instantaneous fuel Economy gauge
- Fuel gauge
- Outside temperature display
- Indicator and warning lamps
- Liquid crystal display
- Program and gear displays for automatic transmission and sequential manual gearbox SMG.



The following table provides an exact comparison, illustrating the functions and symbols that have changed compared to the BMW 3 Series (E46).

Function	E90 High	E46
		
<b>Analogue instrument</b>	Speed Engine speed Fuel gauge Economy control	Speed Engine speed Fuel gauge Economy control Coolant temperature gauge
<b>Indicator lamps</b>	Maximum 15	Maximum 24
<b>Service indicator</b>	CBS4	SIA4
<b>Check control messages</b>	CC system, multicoloured (yellow/red)	----
<b>Pictographs Door open Light failure</b>	Included in CC system	5 door/lid symbols 4 lamp failure symbols
<b>Fuel reserve</b>	Contained in CC system (incl. range indication)	Fixed indicator lamp
<b>Unit master</b>	Implemented	Not used
<b>ESS/SSG indicator</b>	Integrated in main display (codeable)	Additional LC display (specific variant)
<b>Main display</b>	Variable indicator lamps (multicoloured) fixed display (2-line) - Basic (0.5 pitch, single colour) - High (0.32 pitch, single colour)	Display with 7 fixed segment LCD (single colour)
<b>BC functions</b>	Standard features - Range - Average speed - Average fuel consumption	Special features (model-specific)
<b>Clock/outside temperature indicator</b>	Permanent in variable indicator field	Integrated in BC
<b>Dimmer (terminal 58g)</b>	BC function Display/indicators in instrument cluster	Thumb wheel in light switch cluster LSZ
<b>Photosensor</b>	Central photosensor in instrument cluster	Central photosensor in light switch cluster LSZ
<b>Gateway function</b>	No (junction box function)	Yes
<b>Oil level measurement</b>	BC function (petrol engine) Indication in instrument cluster	---
<b>Tyre failure indicator RPA</b>	BC function Display/indicators in instrument cluster	Button Centre column switch cluster SZM
<b>Clock</b>	BD function Indication in instrument cluster	Button in instrument cluster
<b>Date</b>	BD function Indication in instrument cluster	Button in instrument cluster
<b>Condition-based service CBS4</b>	BD function Indication in instrument cluster	---
<b>Personal Profile PP</b>	BD function Indication in instrument cluster	Encoding by dealership network (minimum features)

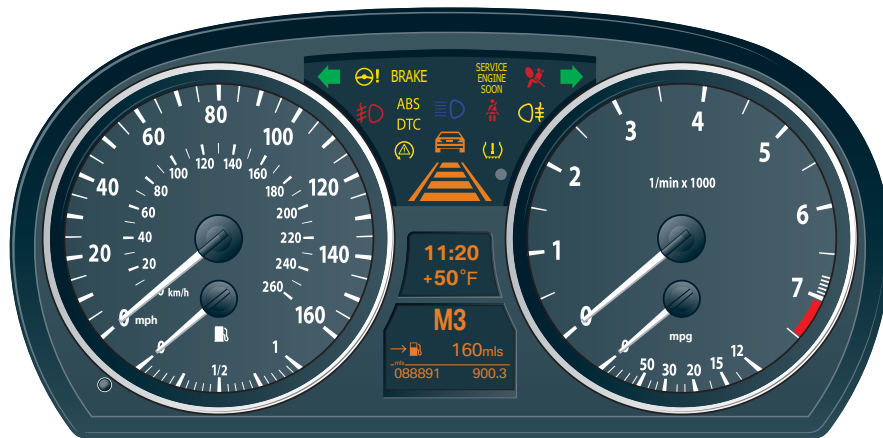

### Speedometer / Tachometer

On the BMW 3 Series, vehicle and engine speed is displayed using the following signal path:

- The DME control unit sends the engine speed on the PT-CAN and K-CAN.
- Using a characteristic curve, step pulses for actuating the stepper motor are assigned to the effective engine speed.

The engine speed range is 7500 rpm on vehicles equipped with the NG6 engines.

### Instantaneous Fuel Economy Gauge

The instantaneous fuel economy gauge is an analogue indicator driven by a stepper motor in the instrument cluster.

The fuel consumption is based on the injector on time signal (ti) sent from the DME control unit via the bus lines to the cluster. The board computer (BC) functions of the instrument cluster calculates for the “real time” fuel consumption.

### Fuel Gauge

The fuel gauge indicator is an analog indicator driven by a stepper motor. The instrument cluster receives a signal from two sending units submerged in the left and right sides of the gas tank. From these two varying voltage signals, fuel level is calculated by the cluster.

The fixed LED for low fuel warning has been eliminated. A pictogram of a fuel gauge now lights up in the instrument cluster when the level drops below 2.1 gallons. A warning tone additionally sounds on reaching the reserve threshold.

### Outside Temperature Display

A temperature sensor (NTC type) mounted on the front bumper cover of the vehicle measures the outside temperature. The analog signal is sent to the cluster to be displayed.

In ignition key position 0, the instrument cluster applies terminal 30g current to the temperature sensor every 10 minutes.

The instrument cluster makes available the current outside temperature in the form of a data telegram via the K-CAN.

## Indicator and Warning Lamps

The indicator and warning lamps are activated by the processor in the instrument cluster.

All important and legally stipulated indicator and warning lamps are activated at terminal 15 ON during the pre-drive check.

The indicator and warning lamps can be illuminated in different colors or combinations.

The significance of the indicator and warning lamps as well as the colour assignments are described in detail later under check control messages.

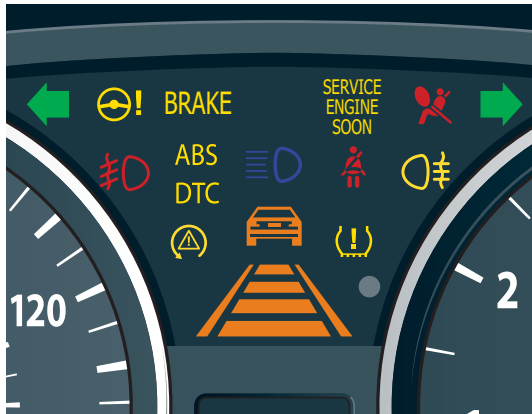

Indicators and Warning Lamps



Liquid Crystal Display Area

## Liquid Crystal Display

The liquid crystal display is divided into two areas.

The time and outside temperature are shown in the upper display along with the CC messages and CBS images.

The on-board computer functions, CBS messages, distance recorder as well as the program display for automatic transmission are shown in the lower display.

### ■ Manipulation Dot

Different data are stored in the instrument cluster and in the CAS when a dot appears to the left of the trip distance recorder.

The manipulation dot is indicated when, for example, comparison of the stored vehicle identification number does not agree.

### ■ Program and Gear Display

The program and gear display is shown in the bottom window in the liquid crystal display on vehicles with automatic or SMG.

The program and gear display shows letters and numbers. The program mode is displayed all the time and is not overwritten by other information.

On manual transmission vehicles, the gear display is blanked out by means of the coding and an enlarged version of the BC display is coded in its place.

---

## Acoustic Generators

Audible warnings are given in support of check control messages if the vehicle is equipped with a RAD2. The instrument cluster controls these warnings via the K-CAN. The warning signals are output by the CCC control unit when installed as an option.

The request for the turn signal indicator is sent by the footwell module via the K-CAN.

## Backlighting

The cluster sends a K-CAN bus signal to other modules on in the vehicle to inform them of backlighting intensity.

While the vehicle lighting is OFF, a phototransister in the instrument cluster graduates the amount of backlighting needed to overcome ambient lighting.

While the vehicle lighting is ON, the backlighting is determined by the adjustment of the KL58g circuit via the BC menu on the cluster. The lighting intensity can be set by using the rocker switch on the turn signal stalk on the steering column.

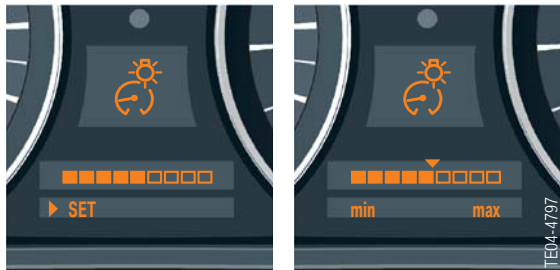

**BC Menu for Adjusting Backlighting**

## Audible Warnings

US vehicles additionally feature an ignition key warning and a seat belt warning.

An uninterrupted warning tone sounds when the driver's door is opened with terminal 15 OFF and the identification transmitter in place.

The audible signal is switched off by removing the identification transmitter, closing the door or after 30 minutes.

The seat belt warning is activated at terminal 15 ON if the seat belt contact is not closed.

The audible warning is intermittent and is no longer than 6 seconds. The indicator and warning lamp remains on.

---

## On-Board Computer

There are two versions of the computer available for the BMW 3 Series:

- On-board computer as basic version
- On-board computer as journey computer (on CCC equipped vehicles)

The basic on-board computer contains the following functions:

- Average fuel consumption 1
- Range
- Current consumption
- Average speed

For the journey computer, the computer is expanded to include the following additional functions:

- Start of journey
- Duration of journey
- Distance covered
- Arrival time
- Average fuel consumption 2
- Average speed 2
- Remaining distance

The individual functions of the basic version of the computer can be shown in succession in the liquid crystal display of the instrument cluster. The data description is the same as that for the other BMW models.

### ■ Display Variants

There are two display variants of the on-board computer functions in the instrument cluster.



1. Computer in vehicle with automatic transmission
2. Computer in vehicle with manual transmission

---

The menu rocker switch must be pressed for at least 2 seconds in one direction to enable fast scrolling of all menu items. The menu is then scrolled through at intervals of 0.5 seconds.

### ■ **Show Displays**

The BC displays are shown and scrolled in the instrument cluster via a menu rocker switch on the steering column stalk for the direction indicator lights.

The individual functions are displayed in the lower display window of the instrument cluster. Once terminal R is switched on, the computer will display the computer function that was displayed last.

All other functions can be selected by means of the rocker switch on the steering column stalk. The order in which the BC functions are shown is always the same.

More information is found later in this section under principles of operation.

## Principals of Operation

The instrument cluster receives information on the wiring harness in the form of analog and digital electrical signals. These signals are processed and displayed in the instrument cluster or passed on as information to other control units.

The instrument cluster on the BMW 3 Series features several functions that have been changed compared to previous models.

### Moving Dial Indicator

Fig. 1 shows the movement sequence of the moving dial indicator based on the rev counter.

The moving dial indicator (2) is driven by:

- ring gear (3) connected to the dial
- pinion (6)
- stepper motor (7) secured to the rear of pc-board (5).

### Moving dial indicator in the BMW 3 Series High instrument cluster

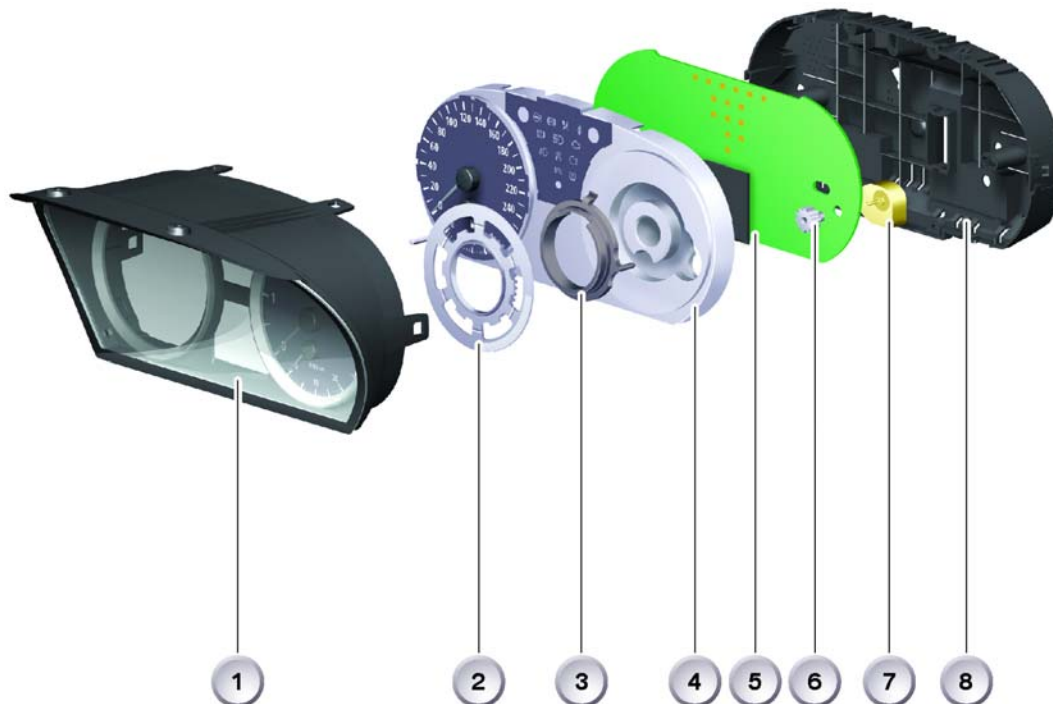

Index	Explanation	Index	Explanation
1	Front frame	5	PC-board
2	Moving dial indicator	6	Pinion
3	Ring Gear	7	Stepper motor
4	Light guide	8	Base Plate

## Fuel Gauge



The fuel reserve level is not indicated by an indicator lamp as in the previous models. A fuel pump symbol lights up for 23 seconds in the liquid crystal display as soon as the reserve level is reached (2.1 gallons).

This display is permanently activated at a range below approx. 31 miles.

## On-Board Computer

A graphic symbol in the upper display window is assigned to each main menu item. Menu items that are deactivated during vehicle operation are not shown (ex. RDC).

Each menu can be interrupted at a certain position by briefly pressing the BC button.

In addition to this active termination, there is an automatic termination that takes place 15 seconds after the last entry.



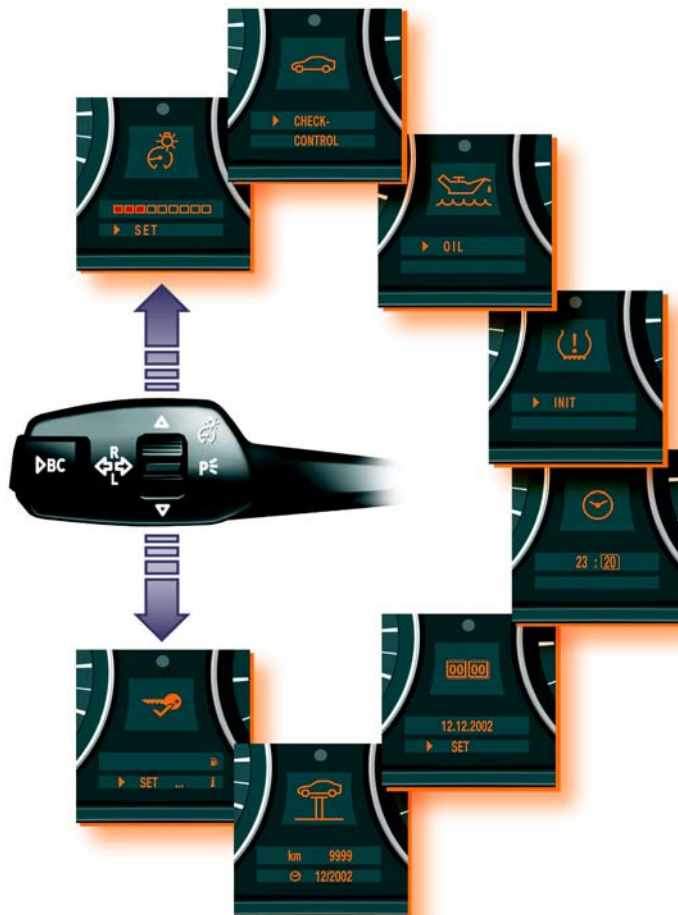





The display for the CCC are shown on the central information display CID.





## ■ BC Main Menu

The following table lists all BC functions that can be selected in the instrument cluster depending on the options.

Function	Display	Active as from	Activities	RAD2	CCC
Instrument lighting		BUS active Terminal 58 g	Settings are stored immediately	X	X
Check Control messages		KL. R EIN	Error message system with max. 72 symbols Error prioritization Audible warning Text message as from radio stage 3/4	X	X
Engine oil level measurement		Terminal 15	Measurement with vehicle stationary and in operation Clock symbol in servicing mode No electrical measurement for diesel engines "Service2" displayed in case of fault	X	
Tyre failure indicator RPA		Terminal 15	Multiple initialization possible	X	
Time		KL. R EIN	Menu selection via cursor	X	X
Date		KL. R EIN	Menu selection via cursor	X	X
CBS4 workshop mode		Terminal 15	Activation via reset button ON time > 10 sec	X	
CBS4		Terminal 15	Setting of main inspection/ exhaust emission inspection same as data entry	X	
Personal profile settings		Terminal 15	Changing/resetting units	X	

X = Can be selected via instrument cluster

## Operating Example:

### 1 - Tire Failure Indicator RDW (not displayed on cluster if CCC/CID equipped)

Initialization must be performed immediately after correcting the tire pressure, a tire change or a wheel change.

The following procedure must be performed to initialize the system:

1. Start the engine but do not drive off.
2. Press the rocker switch on the steering column stalk until the "initializing tire failure indicator" function is shown in the instrument cluster.
3. Confirm the display by briefly pressing the BC button on the steering column stalk.
4. Press and hold the BC button on the steering column stalk for approx. 5 seconds until the RDW display lights up in the instrument cluster. The tire failure indicator is now ready for initialization. If no tick is shown in the display, this indicates that the tyre failure indicator cannot be initialized due to a fault.
5. Release the BC button to conclude initialization.



### 2 - Instrument Lighting

The side lights or low beam headlights must be switched on in order to control the lighting intensity (dimming).

The following procedure must be performed to set the system:

1. Press the rocker switch in the steering column stalk up or down until the "instrument lighting" function appears in the instrument cluster.
2. Confirm the display by briefly pressing the BC button on the steering column stalk.
3. Press the rocker switch up or down to select the lighting intensity. Each setting is saved immediately.
4. Press the BC button on the steering column stalk to exit the menu.



The procedure for selecting and correcting the functions for the following is identical:

- Check Control messages



- Oil level measurement



- Time



- Date



- CBS4 and



- Personal profile (PP) settings.



---

## Service Information

### Test Functions

The test functions are shown in the liquid crystal display of the instrument cluster.

The test functions are used by the BMW service technicians to check the coding. They also provide help in troubleshooting without the diagnostic tester.

#### ■ To Start Function Test

- Terminal R ON or terminal 15 ON
- Press and hold the reset button in the instrument cluster for 10 seconds (set/reset).

The test functions can also be called up by holding down the setting button in the instrument cluster and simultaneously switching on terminal R.

#### ■ Display of Test Functions

The test functions are shown only in the upper liquid crystal display.

#### ■ Locking and Unlocking the Test Functions

Only the first two test functions are freely accessible. As from the third, all further test functions are locked. The functions can be unlocked only via test function 19.

The test functions are unlocked by entering the sum of the last five digits in the vehicle identification number.

#### ■ To End Test Function

- Ignition key at terminal R or terminal 15 ON
- Press and hold the setting button for longer than 5 seconds
- Calling up test function 21 (RESET)

**Note: To protect against unauthorized access, all test functions (with the exception of test 1 and test 2), are locked again after a RESET.**

#### ■ Visual System Test

In the visual system test, all the indicator lamps and lights are lit briefly and the needle instruments are moved from the lower to upper stop and back again.

All the described test functions can also be performed via the BMW diagnostics system.

## ■ Overview of Test Functions

Only the main test functions are listed in the following table. In addition to the majority of test functions there are further equivalent functions for which a similar display appears in the instrument cluster.

Test function	Description	Display
01	Instrument cluster identification - Vehicle identification number, last 5 digits	01.00 FGSTNR AB12345
02	System test	02.00 KI TEST
03	Not used	03.00
04	Electric load values	04.00 VERB-MOM 12,6 l/100 km
05	Range consumption	05.00 RW-VERBR
06	Fuel level	06.00 TANK L R S 24,5 26,7 50
07	Current display values	07.00 KTMP-MOM 104°C
08	Speed	08.00 V-EFF 123 km/h
09	System voltage	09.00 Ub 13,3 V
10	Not used	10.00
11	Units	11.00 ZEIT-EINH 24h
12	Calculated time of arrival	12.00 V-ANKUNFT 67,8 km/h
13	Audible signals	13.00 AUDIO LICHT-WARN BLINKER ZS-WARN
14	Self-diagnostics	14.00 FSP-Einträge
15	I/O ports processor	15.00 PORT 00 01010111
16	Dimming	16.00 DIMMRAD-CAN
17	Contrast	17.00 DISP-HEIZ Ein io
18	Not used	18.00 Not used
19	Locking	19.00 LOCK LOCK: ON LOCK. 25
20	Fuel consumption correction	20.00 KORR-VERBR 1000
21	Reset (software reset)	21.00 Reset?

## Component Replacement and Trial Replacement

There are three possible combinations for replacing the instrument clusters and car access system 2 (CAS 2):

- Instrument cluster defective, CAS 2 OK
- CAS 2 defective, instrument cluster OK
- CAS 2 and instrument cluster must be replaced.

Simultaneous replacement of CAS 2 and the instrument cluster should be avoided. The odometer reading will be lost as a result. It is also possible to carry out a trial replacement of the instrument cluster and CAS 2.

### To Select Check Control Messages

The instrument cluster shows a series of vehicle statuses and consequently generates CC messages.

The following procedure must be performed to select a CC message:

1. Press the rocker switch in the steering column stalk up or down until the "Check Control" function appears in the instrument cluster.
2. Press the BC button on the steering column stalk and confirm the display.
3. Press the rocker switch up or down to select the CC messages.
4. Press the BC button on the steering column stalk to exit the menu.

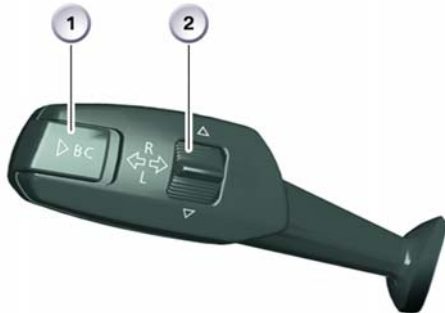

Index	Explanation
1	BC button
2	Rocker switch / Scroll wheel











### Selecting ID Code of Check Control Message









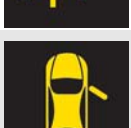

An ID code is assigned to each symbol of a CC message. The ID code can be called up in the instrument cluster with the following procedure:

1. Call up CC message, see steps 1 to 3.
2. Press and hold the BC button until the ID code appears in the instrument cluster.









**Note: The outside temperature or a previous priority 1 message is displayed again if the rocker switch is not operated for 8 seconds.**









**A comprehensive listing of check control messages appear from pages 24-51.**









No.	Control unit	ID code	Fixed indicator lamp	Variable indicator lamp	Check Control message	Message in Central Information Display
02	AFS	321			Active steering deactivated!	Active steering deactivated. Steering behaviour altered. Steering wheel may be at an angle. Possible to continue the journey. Steer with care.
03	AHM	4			Trailer, parking light, left! Check	
04	AHM	5			Trailer, side light, right! Check	
05	AHM	6			Trailer, direction indicator light, left! Check	
06	AHM	7			Trailer, direction indicator light, right! Check	
07	AHM	8			Trailer, brake lights! Check	
08	AHM	9			Trailer, fog light! Check	
09	AHM	75			Trailer electrics failed!	Trailer electrics failed. Trailer lights affected. Have the problem checked by the nearest BMW Service.
10	AHM	90			Trailer reversing light!	
11	CAS	14			Door open!	









No.	Control unit	ID code	Fixed indicator lamp	Variable indicator lamp	Check Control message	Message in Central Information Display
12	CAS	15			Door open!	
13	CAS	16			Door open!	
14	CAS	17			Door open!	
15	CAS	18			Bonnet open! Stop carefully	Bonnet open. Bonnet is not locked. Risk of accident! Stop and close bonnet.
16	CAS	21			Ignition problems!	The engine may only be started with the brake pedal depressed. Contact the nearest BMW Service.
17	CAS	22			Starter motor! Do not stop engine	Starter defective! Engine cannot be restarted. Have the problem checked by the nearest BMW Service.
18	CAS	38			Wrong remote control!	The remote control used does not match the vehicle. Please check.
19	CAS	40			Press brake to start engine	
20	CAS	65			Charge key/ remote control battery!	Battery is automatically recharged in ignition over a longer journey.
21	CAS	66			Remote control! Engine will not start.	Remote control not present or faulty. Engine cannot be started. Refer to Owner's Handbook.



























No.	Control unit	ID code	Fixed indicator lamp	Variable indicator lamp	Check Control message	Message in Central Information Display
22	CAS	67			Remote control battery discharged.	Batteries of remote control with integrated key run down. Replace batteries, see Owner's Handbook.
23	CAS	68			Batteries of remote control for stationary functions!	Batteries of remote control for stationary functions run down. Replace batteries, see Owner's Handbook.
24	CAS	186			ELV! Do not turn off engine	Electric steering lock (ELV) faulty. ELV is no longer released after turning off engine. Engine cannot be started. Do not turn off if engine is running.
25	CAS	187			ELV blocked! Move steering wheel	The "electric steering lock" ELV blocks the engine start function. Move steering wheel so that engine can be started.
26	CAS	205			Remote control! Do not turn off engine	Remote control not in ignition. It may be possible that the engine cannot be restarted, therefore do not turn off. Have the problem checked by the nearest BMW Service.
27	CAS	206			Next time button is pressed: starts engine!	Attention engine start! Keep clear of moving parts in engine compartment. Risk of injury!
28	CAS	208			Comfort access deactivated!	Comfort access deactivated.
29	CAS	209			Remote control inside vehicle!	Remote control inside vehicle. Locking/securing the vehicle from outside is not possible. Remove the remote control from the vehicle.











No.	Control unit	ID code	Fixed indicator lamp	Variable indicator lamp	Check Control message	Message in Central Information Display
30	CAS	217			No remote control!	Remote control not in proximity of vehicle. Locking/securing not possible. Please carry the remote control on your person.
31	CAS	303			Press clutch to start engine	
32	CAS	335			Ignition switched on	
33	CAS	347			Position R, N, D may not be possible	Malfunction Position R, N, D may not be possible! Activate emergency release for selector lever if necessary. Refer to Owner's Handbook. Have the problem checked by the nearest BMW Service.
34	CAS	348			Engage position P before leaving vehicle	Engage stage P before leaving vehicle. Possible malfunction in ignition or transmission/selector lever. Have the problem checked by the nearest BMW Service.
35	CAS	349			Ignition can only be turned off in position P!	
36	CAS CVM	19			Boot open!	
37	DME1_ DDE1	25			Preheating! Please wait	
38	DME1_ DDE1	26			Cruise control defective	Cruise control failed. Possible to continue journey. Have the problem checked by the nearest BMW Service.











No.	Control unit	ID code	Fixed indicator lamp	Variable indicator lamp	Check Control message	Message in Central Information Display
39	DME1_ DDE1	27			Engine oil level! Top up engine oil	Engine oil at minimum level. At the next opportunity top up with 1 litre engine oil, see Owner's Handbook.
40	DME1_ DDE1	28			Engine oil level! Top up engine oil	Engine oil below minimum level. At the next opportunity top up with 1 litre engine oil, see Owner's Handbook.
41	DME1_ DDE1	29			Engine problem! Loss of power	Engine problem Full engine power no longer available. Drive carefully. Have the problem checked by the nearest BMW Service.
42	DME1_ DDE1	30			Engine! Stop carefully	Engine problem. Continuing driving can cause engine damage. Stop and turn off engine. Contact nearest BMW Service.
43	DME1_ DDE1	31			Increased emissions!	Engine problem influencing exhaust emissions. Have checked by your BMW Service as soon as possible.
44	DME1_ DDE1	32			Fuel filler cap open!	Fuel filler cap. Fuel or fuel vapours may escape. Check whether fuel filler cap is closed and locked properly.
45	DME1_ DDE1	33			Engine problem! Drive carefully	Engine problem. Increased engine load can damage catalytic converter. Drive at low engine load. Have checked by nearest BMW Service.
46	DME1_ DDE1	34				

No.	Control unit	ID code	Fixed indicator lamp	Variable indicator lamp	Check Control message	Message in Central Information Display
47	DME1_ DDE1	39			Engine overheating! Stop carefully	Engine overheating. Turn off engine and allow to cool down. Do not open bonnet, danger of scalding. Risk of scalding! Contact the nearest BMW Service.
48	DME1_ DDE1	49			Particle filter fault!	Particle filter malfunction. Possible to continue journey. Have the problem checked by the nearest BMW Service.
49	DME1_ DDE1	148			Brake light control failed!	Brake light failed. Have the problem checked by the nearest BMW Service.
50	DME1_ DDE1	182			Oil level sensor malfunction!	Oil level sensor malfunction! Have the problem checked by BMW Service as soon as possible.
51	DME1_ DDE1	212			Engine oil pressure! Stop carefully	Engine oil pressure too low. Engine damage possible. Turn off engine. Not possible to continue journey. Contact the nearest BMW Service.
52	DME1_ DDE1	213			Battery not charged!	Alternator malfunction. Battery is no longer charged. Switch off unnecessary electric loads. Have checked by nearest BMW Service.
53	DME1_ DDE1	220			Increased battery discharge!	High rate of battery discharge with engine stationary. It may not be possible to restart engine. Switch off unnecessary electric loads. Have the problem checked by BMW Service.
54	DME1_ DDE1	229			Battery charge very low!	Battery charge very low. Recharge by driving or using external charger. Automatic electric load will soon shut down!





No.	Control unit	ID code	Fixed indicator lamp	Variable indicator lamp	Check Control message	Message in Central Information Display
55	DME1_ DDE1	247			Battery monitoring failed!	Automatic monitoring of battery charge status failed. Have the problem checked by BMW Service.
56	DME1_ DDE1	257			Engine too hot! Drive carefully	Engine temperature too high Drive with moderation to allow the engine to cool down. If problem recurs, contact BMW Service.
57	DME1_ DDE1	304			Battery! Check	Battery aged. Have checked by your BMW Service.
58	DME1_ DDE1	305			Battery terminals! Check	Battery not securely connected. Electrical power supply endangered. Have the problem checked by the nearest BMW Service.
59	DME1_ DDE1	306			Battery charge very low!	Battery charge very low. Electric convenience functions switched off to relieve load on battery. These functions will be available again after recharging the battery.
60	DSC module	24			DSC failed! Drive carefully	DBC failure. nNo additional DBC assistance while emergency braking. Drive moderately.  Have the problem checked by BMW Service as soon as possible.
61	DSC module	35			DSC failed! Drive carefully	DSC failed. Restricted driving stability when accelerating and cornering. Drive carefully.  Have the problem checked by BMW Service as soon as possible.
62	DSC module	36			DSC deactivated!	You have switched off DSC. Reduced driving stability when cornering and accelerating.







No.	Control unit	ID code	Fixed indicator lamp	Variable indicator lamp	Check Control message	Message in Central Information Display
63	DSC module	71			Brake pads! Replace	The brake pads are worn. Have replaced by nearest BMW Service.
64	DSC module	74			Brake fluid! Stop carefully	Insufficient brake fluid. Braking effect reduced. Stop carefully Contact the nearest BMW Service.
65	DSC module	184			DTC activated, DSC restricted!	DTC activated. Dynamic traction control DTC increases forward propulsion on loose ground, reduces driving stability.
66	DSC module	215				
67	DSC module	236			Control systems! Drive carefully	Brake and driving control systems failure. Reduced braking and driving stability. Avoid braking abruptly if possible. Have the problem checked by the nearest BMW Service.
68	DSC module	237			Drive control system! Drive carefully!	Driving stability Driving control system failed. Reduced driving stability when cornering. Drive carefully. Have the problem checked by the nearest BMW Service.
69	DSC module	330			HDC currently not available!	HDC not available. Automatic brake intervention deactivated for safety reasons as brakes are overheated. Shift down gear and drive carefully to reduce temperature.
70	DSC module	331			HDC active!	









No.	Control unit	ID code	Fixed indicator lamp	Variable indicator lamp	Check Control message	Message in Central Information Display
71	DSC module	332			HDC deactivated!	HDC deactivated. Hill Descent Control HDC is deactivated at speed above 60 km/h (37 mph). Reactivation possible at speed below 35 km/h (22 mph).
72	DSC module	333			No HDC control! Drive slower	HDC not possible! Control range ends at 35 km/h (22 mph). Reduce speed correspondingly in order to use HDC.
73	DSC module	334			End of assembly line: Standardize RPA	End of assembly line mode: Tyre failure indicator must be standardized! Refer to Owner's Handbook.
74	DSC module	336				
75	DSC module	352			Brakes too hot! Allow to cool down	Brakes too hot Critical temperature as the result of high permanent load. Danger of reduced braking effect! Allow brakes to cool down. Stop if necessary.
76	DSC module	353			Brakes overheated! Allow to cool down	Brakes overheated. Critical temperature exceeded. Braking effect no longer guaranteed. Stop at the next opportunity and allow brakes to cool down significantly.
77	DSC module	354			Start-off assistance inactive!	Start-off assistance inactive Caution, vehicle may roll back! Have checked by your BMW Service at the next opportunity.
78	DSC module (EBV/CBC)	42			Control systems! Drive carefully	Brake and driving control systems failure. Drive with moderation and avoid hard braking. Have the problem checked by the nearest BMW Service.











No.	Control unit	ID code	Fixed indicator lamp	Variable indicator lamp	Check Control message	Message in Central Information Display
79	DSC module (RPA)	50			Tyre failure indicator failed!	Tyre failure indicator failed. Tyre failure is not detected. Have the problem checked by BMW Service as soon as possible.
80	DSC module (RPA)	63			Tyre failure!	Tyre failure. Stop carefully. Refer to Owner's Handbook for wheel change procedure. Runflat tyres: Possible to continue driving at max. speed of 80 km/h for limited distance, see Owner's Handbook. Have tyres checked by the nearest BMW Service .
81	DXC	350			4x4 system defective! Drive carefully	4x4 system defective Driving stability restricted. Drive with moderation. Have the problem checked by BMW Service as soon as possible.
82	DXC	351			4x4 system and DSC failed!	4x4 system and DSC failed!. Driving stability restricted. Drive with moderation. Have the problem checked by BMW Service as soon as possible.
83	DXC	369			4x4 system, DSC and ABS failed!	4x4 system, DSC and ABS failed. Driving stability restricted. Drive with moderation. Have the problem checked by BMW Service as soon as possible.
84	DXC	370			4x4 system, DSC, ABS and EMERGENCY EBV failed!	4x4 system, DSC, ABS and EMERGENCY EBV failed! Driving stability restricted. Drive with moderation. Have checked immediately by your BMW Service.
85	EGS_SSG	104			Gearbox temperature! Drive carefully	Risk of gearbox overheating. Gearshift program with restricted driving active. Avoid high engine load.



No.	Control unit	ID code	Fixed indicator lamp	Variable indicator lamp	Check Control message	Message in Central Information Display
86	EGS_SSG	105			Gearbox temperature! Stop carefully	Transmission overheated. Stop vehicle and engage Park. After gearbox has cooled down, continue driving with moderation. If gearbox overheats again, have the problem checked by the nearest BMW Service.
87	EGS_SSG	171			Transmission malfunction! Drive carefully	Transmission malfunction. Emergency program active. P, R, N, D possible (forwards only in 3rd and 5th gear). Gear may be engaged without braking. Drive with moderation. Have the problem checked by the nearest BMW Service.
88	EGS_SSG	172			Transmission malfunction! Drive carefully	Transmission malfunction. Emergency program active. It may not be possible to engage reverse gear. Reduced acceleration. Drive carefully! Have the problem checked by the nearest BMW Service.
89	EGS_SSG	178			Transmission in position N!	Vehicle not protected against rolling away. Engage gear or apply parking brake.
90	EGS_SSG	248			Gear can be engaged without brake.	Brake signal malfunction. Gear can be engaged without brake. Press brake before engaging gear. Turn off engine before leaving vehicle. Have the problem checked by BMW Service as soon as possible.









No.	Control unit	ID code	Fixed indicator lamp	Variable indicator lamp	Check Control message	Message in Central Information Display
91	EGS_SSG	254			Transmission malfunction! Drive carefully	Transmission malfunction. Emergency program active. Acceleration may be reduced.  Drive carefully. Have the problem checked by the nearest BMW Service.
92	EGS_SSG	287			Clutch overheated!	Clutch overheated. If possible, stop vehicle or drive off at speed.
93	EGS_SSG	288			Transmission malfunction! Drive carefully	Transmission malfunction. Emergency program activated. Only R, N and 1st to 3rd gear available. Have the problem checked by the nearest BMW Service.
94	EGS_SSG	289			Transmission malfunction! Drive carefully	Transmission malfunction. Emergency program activated. Only R, N and 1st to 3rd gear available. Have the problem checked by the nearest BMW Service.
95	EGS_SSG	290			Transmission malfunction! Drive carefully	Transmission malfunction. Possible to continue journey at moderate speed. Journey can no longer be continued after stopping. Contact the nearest BMW Service.
96	EGS_SSG	291			Transmission malfunction! Drive carefully	Transmission malfunction. Emergency program activated. Only D, N and R available. Have the problem checked by the nearest BMW Service.









No.	Control unit	ID code	Fixed indicator lamp	Variable indicator lamp	Check Control message	Message in Central Information Display
97	EGS_SSG	292			Transmission! Re-engage gear	Transmission malfunction! Position N is engaged automatically when vehicle is stationary. Have the problem checked by the nearest BMW Service.
98	EGS_SSG	293			Start: select pos. N and press brake	Before starting the engine press the brake and shift selector lever to position N.
99	EGS_SSG	302			Transmission position P not engaged!	Transmission position P is not engaged! Vehicle may roll away!
100	EGS_SSG	307			Transmission malfunction! Drive carefully	Transmission malfunction. Several functions may be faulty. It is possible to engage gear without applying the brake. Drive with moderation. Have the problem checked by the nearest BMW Service!
101	EGS_SSG	322			Transmission! Teach-in active	
102	EGS_SSG	323			Clutch! Teach-in active	
103	EGS_SSG	325			Transmission in position N!	
104	EGS_SSG	368			Transm. failsafe!	Transm. failsafe! Possible to continue journey. Have the problem checked by the nearest BMW Service!

No.	Control unit	ID code	Fixed indicator lamp	Variable indicator lamp	Check Control message	Message in Central Information Display
105	EHC	45			Level control system failure!	Level control system failure! Ground clearance and driving comfort reduced. Avoid high speed cornering. Have fault checked by BMW Service as soon as possible.
106	EHC	245			Level control System malfunction!	Level control System malfunction. Possible reduction in driving comfort. Have the problem checked by BMW Service.
107	EKP	216			Fuel pump fault! Drive moderately	Fuel pump. Fuel pump fault. Engine may stall. Possible reduction in engine power Drive moderately! Have the problem checked by the nearest BMW Service.
108	EKP	309			Fuel pump!	Fuel pump malfunction. Possible to continue journey. Have the problem checked by the nearest BMW Service
109	EPS	73			EPS inoperative	
110	FRM	87			Rear light, right, failure!	Rear light, right, failure. Have the problem checked by the nearest BMW Service.
111	FRM	88			Dipped beam, left, failure!	Dipped beam, left, failure. Have the problem checked by the nearest BMW Service.
112	FRM	89			Dipped beam, right, failure!	Dipped beam, right, failure. Have the problem checked by the nearest BMW Service.
113	FRM	111			Left licence plate light failed!	Left licence plate light, failure. Have the problem checked by the nearest BMW Service.











No.	Control unit	ID code	Fixed indicator lamp	Variable indicator lamp	Check Control message	Message in Central Information Display
114	FRM	113			Side light switched on!	
115	FRM	114			Left rear fog light defective!	Fog light, rear left, failure Have the problem checked by the nearest BMW Service.
116	FRM	115			Reversing light, right, failure!	Right reversing light failed. Have the problem checked by the nearest BMW Service.
117	FRM	116			Turn indicator, rear left, failure!	Turn indicator, rear left, failure. Have the problem checked by the nearest BMW Service.
118	FRM	117			Reversing light, left, failure!	Reversing light, left, failure. Have the problem checked by the nearest BMW Service.
119	FRM	118			Rear light, right, failure!	Rear light, right, failure. Have the problem checked by the nearest BMW Service.
120	FRM	119			Front right direction indicator failed!	Turn indicator, front right, failure. Have the problem checked by the nearest BMW Service.
121	FRM	120			Dipped beam, left, failure!	Dipped beam, left, failure. Have the problem checked by the nearest BMW Service.
122	FRM	121			Dipped beam, right, failure!	Dipped beam, right, failure. Have the problem checked by the nearest BMW Service.
123	FRM	122			Front left direction indicator failed!	Turn indicator, front left, failure. Have the problem checked by the nearest BMW Service.
124	FRM	123			Right tail light failed!	Rear light, left, failure. Have the problem checked by the nearest BMW Service.



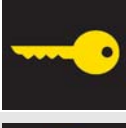







No.	Control unit	ID code	Fixed indicator lamp	Variable indicator lamp	Check Control message	Message in Central Information Display
125	FRM	124			Right direction indicator repeater failed!	Right direction indicator repeater failed . Have the problem checked by the nearest BMW Service.
126	FRM	125			Turn indicator, rear right, failure!	Turn indicator, rear right, failure. Have the problem checked by the nearest BMW Service.
127	FRM	126			Right fog light defective!	Right fog light failed. Have the problem checked by the nearest BMW Service.
128	FRM	127			Side turn indicator, left, failure!	Left direction indicator repeater failed. Have the problem checked by the nearest BMW Service.
129	FRM	128			Left high beam headlight failed!	Left high beam headlight failed. Have the problem checked by the nearest BMW Service.
130	FRM	129			Right rear fog light defective!	Fog light, rear right, failure. Have the problem checked by BMW Service.
131	FRM	130			Right high beam headlight failed!	Right high beam headlight failed. Have the problem checked by the nearest BMW Service.
132	FRM	131			Parking light front left, failure!	Front left side light failed. Have the problem checked by the nearest BMW Service.
133	FRM	132			Front right side light failed!	Front right side light failed. Have the problem checked by the nearest BMW Service.
134	FRM	133			Right tail light failed!	Left tail light failed. Have the problem checked by the nearest BMW Service.







No.	Control unit	ID code	Fixed indicator lamp	Variable indicator lamp	Check Control message	Message in Central Information Display
135	FRM	134			Right brake light failed!	Right brake light failed. Have the problem checked by the nearest BMW Service.
136	FRM	135			Third brake light failed!	Third brake light failed. Have the problem checked by the nearest BMW Service.
137	FRM	136			Left brake light failed!	Left brake light failed. Have the problem checked by the nearest BMW Service.
138	FRM	137			Right licence plate light failed!	Right licence plate light failed. Have the problem checked by the nearest BMW Service.
139	FRM	138			Left fog light defective!	Left fog light failed. Have the problem checked by the nearest BMW Service.
140	FRM	196			Front right direction indicator failed!	Front right direction indicator failed. Have the problem checked by the nearest BMW Service.
141	FRM	197			Front left direction indicator failed!	Front left direction indicator failed. Have the problem checked by the nearest BMW Service.
142	FRM	231			Light system! Stop carefully	Light system. Indicator lights and possibly direction indicators, fog light, high beam headlight and headlight flasher inoperative. Stop vehicle, check and continue journey cautiously. Have the problem checked by the nearest BMW Service.



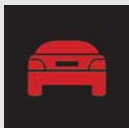
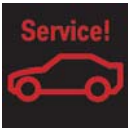





No.	Control unit	ID code	Fixed indicator lamp	Variable indicator lamp	Check Control message	Message in Central Information Display
143	FRM	256			Headlight vertical aim control!	Headlight vertical aim control malfunction! Optimum illumination of road not possible headlights may dazzle oncoming traffic. Have the problem checked by BMW Service as soon as possible.
144	FRM	259			Power windows anti-trapping function!	Power windows. Anti-trapping function deactivated.
145	FRM	261			Power windows anti-trapping function!	Power windows. Anti-trapping function failed. Have the problem checked by the nearest BMW Service.
146	FRM	345			Right brake/tail light!	Right brake/tail light failed. Have the problem checked by the nearest BMW Service.
147	FRM	346			Left brake/tail light!	Left brake/tail light failed. Have the problem checked by the nearest BMW Service.
148	FRM	371			Licence plate light failed!	Licence plate light failed. Have the problem checked by the nearest BMW Service.
149	FRM	372			Left brake force light defective	Left brake force light failed. Have the problem checked by the nearest BMW Service.
150	FRM	373			Right brake force light defective	Right brake force light failed. Have the problem checked by the nearest BMW Service.
151	FRM_ ALC	295			Cornering lights failure! !	Adaptive Cornering lights failure! ! Possible to continue journey with caution. Have the problem checked by BMW Service.























No.	Control unit	ID code	Fixed indicator lamp	Variable indicator lamp	Check Control message	Message in Central Information Display
152	JB	164			Washer fluid level too low!	Not enough fluid in washer-fluid reservoir. Top up the washer fluid at the earliest opportunity, see Owner's Handbook.
153	JB	166			Coolant level too low!	Engine coolant level too low. Risk of engine damage. At next opportunity, top up coolant, see Owner's Handbook. Caution: Risk of scalding!
154	JB (instrument cluster)	207			Electronics malfunction! Stop vehicle carefully	Central electronics failure. It is not possible to continue your journey. Contact the nearest BMW Service.
155	Instrument cluster	0			Reports no faults	
156	Instrument cluster	13			Remote control key!	
157	Instrument cluster	37			Trigger	
158	Instrument cluster	41			Service due!	Service due. Unable to inform your BMW Service automatically. Contact your BMW Service.
159	Instrument cluster	55			Release parking brake	
160	Instrument cluster	60			Speedometer display fault!	Speedometer display malfunction. Have the problem checked by the nearest BMW Service.
161	Instrument cluster	62			Speed limit exceeded	











No.	Control unit	ID code	Fixed indicator lamp	Variable indicator lamp	Check Control message	Message in Central Information Display
162	Instrument cluster	78			Speed limit exceeded!	
163	Instrument cluster	79			Outside temperature %s	
164	Instrument cluster	80				
165	Instrument cluster	165			Outside temperature %s	
166	Instrument cluster	167			Set time and date	Battery was disconnected, time and date displays are no longer correct. Reset, see Owner's Handbook.
167	Instrument cluster	258				
168	Instrument cluster	275			Fuel reserve!	
169	Instrument cluster	279			Driver's seat back not engaged!	Driver's seat back not engaged! Increased risk of injury in event of collision, seat belt ineffective! Engage seat back.
170	Instrument cluster	280			Front passenger's seat back not engaged!	Front passenger's seat back not engaged. Increased risk of injury in event of collision, belt ineffective! Engage seat back.
171	Instrument cluster	281			Service due!	





No.	Control unit	ID code	Fixed indicator lamp	Variable indicator lamp	Check Control message	Message in Central Information Display
172	Instrument cluster	282				
173	Instrument cluster	283				
174	Instrument cluster	284			Service overdue!	
175	Instrument cluster	285			No service due	
176	Instrument cluster	286			Range %s	
177	Instrument cluster	301			Seat backrest monitoring defective!	Seat backrest monitoring failed. Lock backrest. Have the problem checked by the nearest BMW Service.
178	Instrument cluster	308				
179	LDM	1			ACC inactive! Drive moderately	Active cruise control. ACC inactive due to slippery conditions. Keep your distance and drive moderately! Activate ACC as required under appropriate driving conditions.
180	LDM	2			ACC inactive! Keep your distance	Active cruise control. ACC inactive Active Cruise Control (ACC) not available. Keep your distance! Wipe the sensor clean at the next opportunity, see Owner's Handbook.

No.	Control unit	ID code	Fixed indicator lamp	Variable indicator lamp	Check Control message	Message in Central Information Display
181	LDM	3			ACC failure! Keep your distance	Active cruise control. ACC deactivated . Keep your distance! Have the problem checked by BMW Service.
182	LDM	59			ACC deactivated! ! Parking brake	Active Cruise Control ACC deactivated due to operation of parking brake. Reactivate ACC if desired.
183	LDM	69			ACC inactive! Keep your distance	Active Cruise Control (ACC) is inactive below approximately 20 mph (30 km/h). Keep your distance! Reactivate ACC if required.
184	LDM	85			ACC inactive! Excessive braking	Active cruise control (ACC) inactive due to long hill descent. Keep your distance! Reactivate ACC if required.
185	LDM	176			ACC fault! Keep your distance	Sensor of Active Cruise Control ACC possibly dirty. Detection of preceding vehicles restricted (see Owner's Handbook).\nKeep your distance!
186	LDM	276			Engine speed! Select higher gear	Engine speed too high. Select a higher gear if driving situation permits.
187	LDM	277			ACC inactive! Keep your distance	Active cruise control deactivated: Selected gear inappropriate for driving situation. Change gear and activate ACC as required.
188	LDM	278			Engine speed! Shift down	Engine speed too low. Select lower gear if driving situation permits.
189	LDM	337			DCC failed!	Dynamic cruise control DCC failed. Have the problem checked by BMW Service.



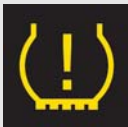

No.	Control unit	ID code	Fixed indicator lamp	Variable indicator lamp	Check Control message	Message in Central Information Display
190	LDM	338			DCC deactivated! Parking brake	Dynamic cruise control DCC deactivated due to applied parking brakes. Reactivate DCC if required.
191	LDM	339			DCC deactivated! Excessive braking	Dynamic cruise control DCC deactivated due to long hill descent. Reactivate DCC if required.
192	LDM	340			DCC deactivated! Drive with moderation.	Dynamic cruise control DCC deactivated due to slippery conditions. Drive with moderation. Activate DCC as required under appropriate driving conditions.
193	LDM	341			DCC deactivated!	Dynamic cruise control DCC deactivated. Selected gear inappropriate for driving situation. Change gear and activate DCC as required.
194	LDM	342			DCC deactivated!	Dynamic cruise control DCC is inactive below 30 km/h (20 mph). Reactivate DCC if required.
195	MDS	260			Sunroof anti-trapping function!	Sliding sunroof anti-trapping function inactive. Have the problem checked by the nearest BMW Service.
196	MDS	262			Sunroof anti-trapping function!	Sliding sunroof anti-trapping function failed. Have the problem checked by the nearest BMW Service.
197	MRS	46			Fasten seat belt	
198	MRS	76				

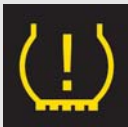

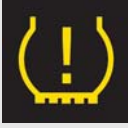

No.	Control unit	ID code	Fixed indicator lamp	Variable indicator lamp	Check Control message	Message in Central Information Display
199	MRS	77				
200	MRS	91			Fasten seat belt	
201	MRS	92			Front passenger restraint system faulty!	Passenger seat belt. Seat belt pretensioner or seat belt force limiter malfunction. Ensure your seat belt is fastened despite the fault! Have the problem checked by the nearest BMW Service.
202	MRS	93			Driver restraint system faulty!	Driver's seat belt. Seat belt pretensioner or seat belt force limiter malfunction. Ensure your seat belt is fastened despite the fault! Have the problem checked by the nearest BMW Service.
203	MRS	94			Restraint system, rear left, faulty!	Left seat belt in rear compartment. Seat belt pretensioner malfunction. Ensure your seat belt is fastened despite the fault! Have the problem checked by the nearest BMW Service.
204	MRS	95			Restraint system, rear right, faulty!	Right seat belt in rear compartment. Seat belt pretensioner malfunction. Ensure your seat belt is fastened despite the fault! Have the problem checked by the nearest BMW Service.
205	MRS	97			Restraint systems malfunction!	Restraint systems. Function of airbags, seat belt pretensioner and belt force limiter faulty. Ensure your seat belt is fastened despite the fault! Have the problem checked by the nearest BMW Service.

No.	Control unit	ID code	Fixed indicator lamp	Variable indicator lamp	Check Control message	Message in Central Information Display
206	MRS	106			Rear left side airbag faulty!	Left rear compartment airbag. Side airbag faulty. Do not use left rear seat if possible. Have the problem checked by the nearest BMW Service.
207	MRS	107			Side airbag, rear right faulty!	Right rear compartment airbag. Side airbag faulty. Do not use right rear seat if possible. Have the problem checked by the nearest BMW Service.
208	MRS	108			Driver airbags faulty!	Driver airbags. Airbag malfunction. Have the problem checked by the nearest BMW Service.
209	MRS	109			Front passenger airbags faulty!	Passenger airbags. Airbag malfunction. If possible leave front passenger seat unoccupied. Have the problem checked by the nearest BMW Service.
210	MRS	181				
211	PDC	195			PDC failure!	Park distance control PDC failed. Have the problem checked by the nearest BMW Service as soon as possible.
212	RDC	139			Front left tyre failure!	Tyre failure. Stop carefully and change wheel, see Owner's Handbook. Runflat tyres (RSC): possible to continue journey at max. speed of 80 km/h. Restricted distance, see Owner's Handbook. Have the problem checked by the nearest BMW Service.

No.	Control unit	ID code	Fixed indicator lamp	Variable indicator lamp	Check Control message	Message in Central Information Display
213	RDC	140			Rear right tyre failure!	Tyre failure. Stop carefully and change wheel, see Owner's Handbook. Runflat tyres (RSC): possible to continue journey at max. speed of 80 km/h. Restricted distance, see Owner's Handbook. Have the problem checked by the nearest BMW Service.
214	RDC	141			Rear left tyre failure!	Tyre failure. Stop carefully and change wheel, see Owner's Handbook. Runflat tyres (RSC): possible to continue journey at max. speed of 80 km/h. Restricted distance, see Owner's Handbook. Have the problem checked by the nearest BMW Service.
215	RDC	142			Tyre pressure! Check	Tyre pressure too low or too high. Check and correct, see Owner's Handbook or inflation pressure sticker.
216	RDC	143			Front right tyre failure!	Tyre failure. Stop carefully and change wheel, see Owner's Handbook. Runflat tyres (RSC): possible to continue journey at max. speed of 80 km/h. Restricted distance, see Owner's Handbook. Have the problem checked by the nearest BMW Service.
217	RDC	144			Tyre pressure control failure!	Temporary operating fault in RDC tyre pressure control (due to external cause or additional RDC wheels in vehicle). Possible to continue journey.



No.	Control unit	ID code	Fixed indicator lamp	Variable indicator lamp	Check Control message	Message in Central Information Display
218	RDC	145			Tyre pressure control deactivated!	Tyre pressure control RDC not available as wheel without sensor is mounted. Possible to continue the journey. Have the problem checked by the nearest BMW Service.
219	RDC	147			Tyre puncture!	Tyre failure. Stop carefully and change wheel, see Owner's Handbook. Runflat tyres (RSC): possible to continue journey at max. speed of 80 km/h. Restricted distance, see Owner's Handbook. Have the problem checked by the nearest BMW Service.
220	RDC	149			Tyre pressure control failure!	Tyre pressure control RDC not available. Tyre failure and pressure loss cannot be detected. Have the problem checked by the nearest BMW Service.
221	RDC	192			RDC initialising during journey!	RDC is initialized. RDC not available for approx. 15 to 30 minutes. Tyre failure can temporarily not be detected. Initialization while driving.
222	RDC	265			Tyre pressure! Check again	Tyre pressure. Right/left pressure difference too high. Recheck tyre pressures, see Owner's Handbook or inflation pressure label.
223	RDC	327			RDC initialising during journey!	RDC is initialized. RDC not available for up to 3 minutes. Tyre failure can temporarily not be detected. Initialization while driving.

No.	Control unit	ID code	Fixed indicator lamp	Variable indicator lamp	Check Control message	Message in Central Information Display
224	TCU	296			No SOS calls! Mobile phone?	SOS calls not possible. Insert mobile phone and switch on.
225	TCU	297			Assist emergency call not enabled!	BMW Assist emergency call not possible as not enabled. Refer to BMW Assist agreement and check settings.
226	TCU	298			Assist emergency call not available!	BMW Assist emergency call. BMW Assist emergency call not possible in this country. Consult conditions for BMW Assist roaming.
227	TCU	299			SOS call system fault!	SOS call system fault. SOS call system functions restricted or failed. Have the problem checked by the nearest BMW Service.
228	TCU	300			Assist emergency call not available! SIM?	BMW Assist emergency call not available. SIM card not inserted or unusable.

---

## Personal Profile

The "Personal profile" system allows the driver to set several functions of the BMW 3 Series to suit his/her personal requirements.

Personal profile stores the data entered by the driver such as automatic setting of the outside mirrors or speed-dependent volume in the corresponding control units.

As soon as the vehicle is unlocked using the remote control, the system recognizes the corresponding settings belonging to the remote control.

Up to three different basic settings can be adapted for three different persons. The precondition is that each of the three persons has his/her own remote control. The BMW 3 Series caters for the driver's personal requirements.

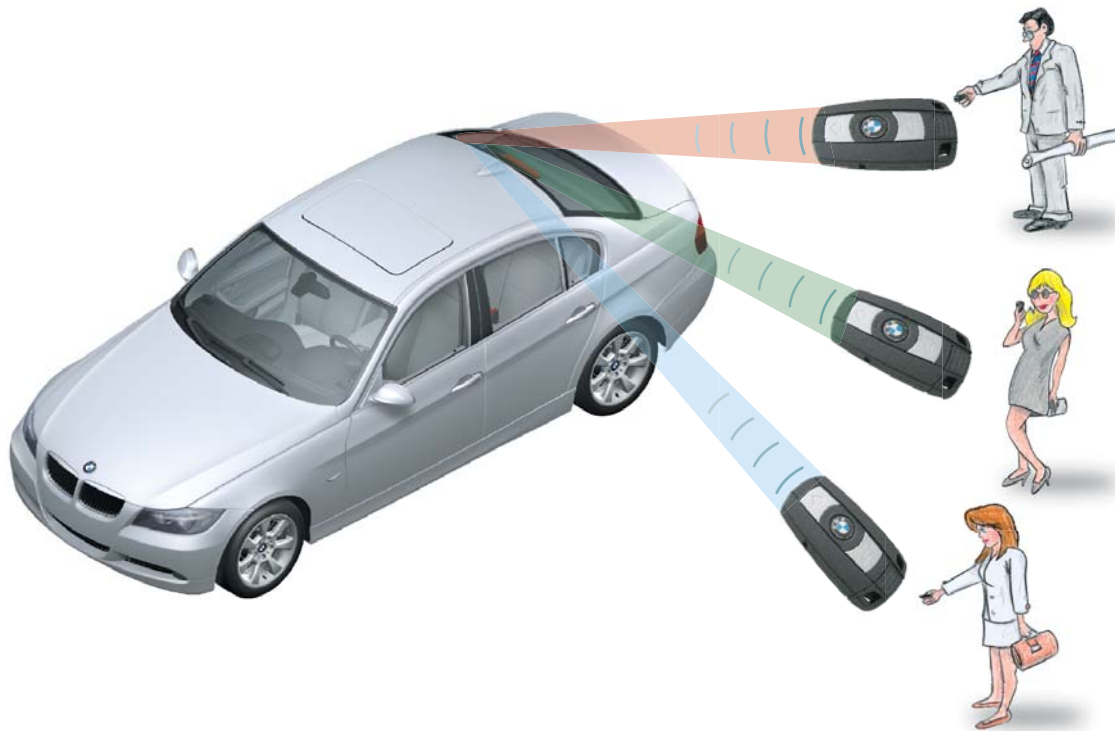

**Note: Up to three different basic settings can be adapted for three different personalizations.**

---

Display in the instrument cluster Display formats and units of measure The following display formats and units of measure can be changed in the instrument cluster:

- Fuel consumption (l/100 km, mpg, km/l)
- Distance (km, mls)
- Time format (12h/24h)
- Date format (dd/mm, mm/dd)
- Temperature (°C, °F)
- Reset of display formats and units of measure, the factory setting is adopted.

The procedure for selecting and changing all display formats and units of measure is identical. By way of example, the procedure for changing the unit of measure is described in detail.

### Changing Unit of Measure

The following procedure must be carried out in order to change the unit of measure:

1. Press the rocker switch in the steering column stalk up or down until the "Personal Profile" function appears in the instrument cluster.
2. Press the BC button on the steering column stalk.
3. Press the rocker switch up or down until the required unit of measures is shown.
4. Press the BC button on the steering column stalk.
5. Use the rocker switch to make the necessary change.
6. Press the BC button to adopt the change.

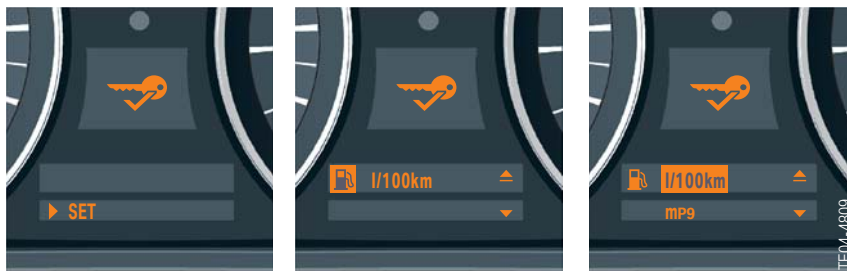

Changing Unit of Measure

**Note: On a vehicle equipped with a CCC/CID, the changes in personal profile are made using the vehicle settings menu in the iDrive system. The menu will not be displayed on the cluster.**

## Central Information Display (CID)

The central information display (CID) is the graphic display unit for the user interface of all convenience functions and several vehicle functions. Only vehicles equipped with navigation system (option 609) will be equipped with a CID.

The main menu consists of four menu items:

- Communication
- Navigation
- Entertainment
- Climate control.

All individual user settings are combined under the additional "Settings" menu.

The button for selecting the main menu is located behind the controller in the center console.

As on other BMW models, the system is operated by means of the the controller.

The design of the central information display is identical to that of the CID installed in the BMW 5 Series. In the BMW 3 Series, the same software is used in the central information display as in the BMW 5 Series and 6 Series.



**Central Information Display (CID)**

# IPO

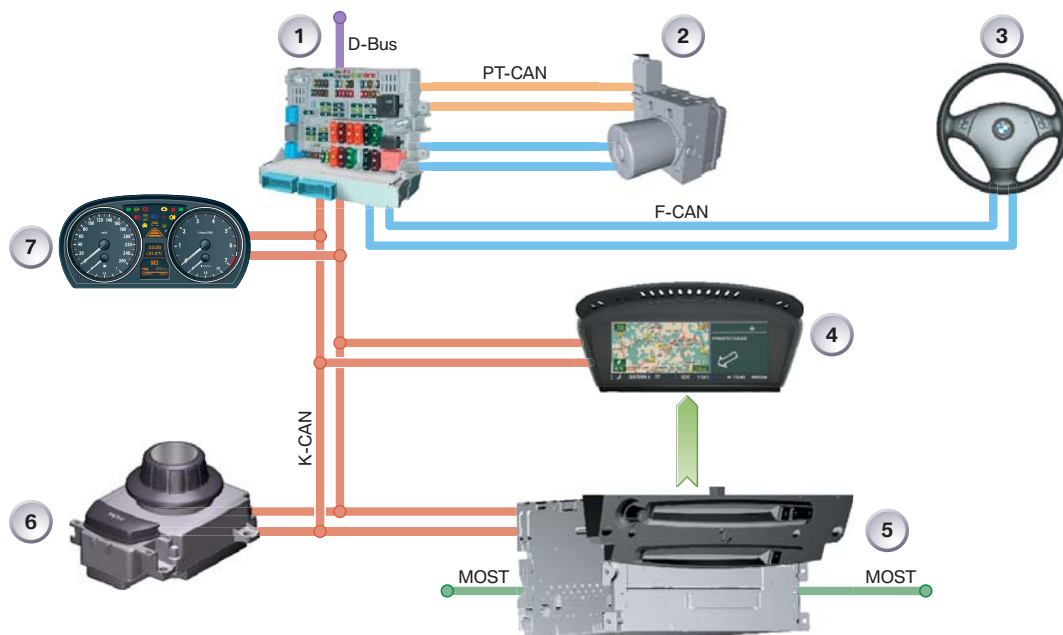

Index	Explanation
1	Junction box control unit
2	DSC control module
3	Multifunction steering wheel
4	Central information display (CID)
5	Car Communication Computer
6	Controller
7	Instrument cluster

# System Circuit Diagram

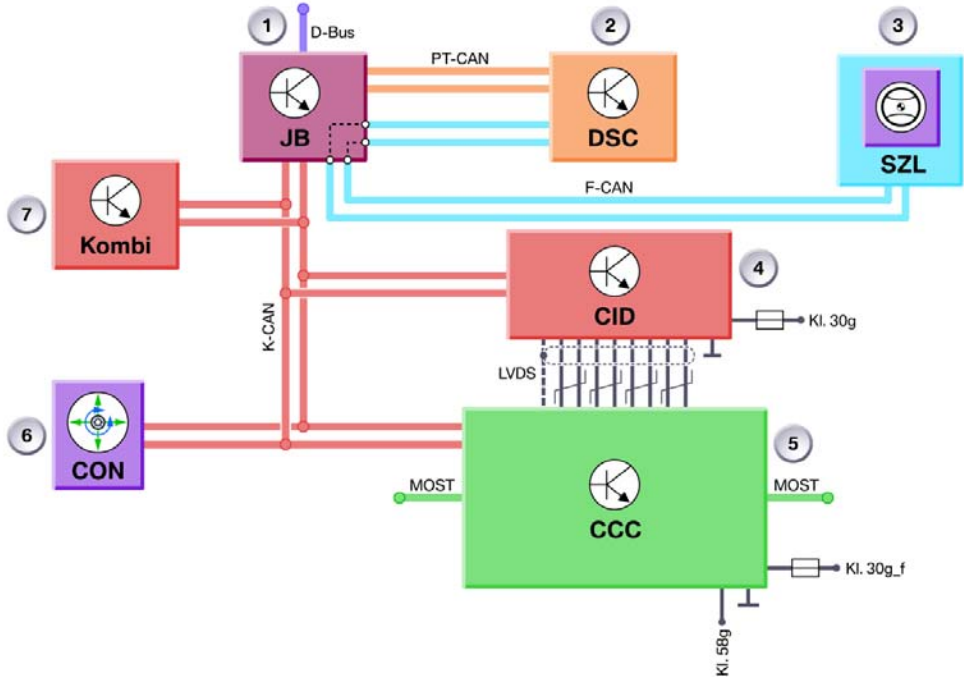

Index	Explanation
1	Junction box control unit
2	DSC control module
3	Multifunction steering wheel
4	Central information display (CID)
5	Car Communication Computer
6	Controller
7	Instrument cluster

---

## System Components

### Central Information Display (CID)

The central information display CID is secured with two torx-head tapping screws in the central area of the instrument panel.

The CID comprises the following two components:

- Casing with integral electronic module
- Casing attachment with glass cover.

The controller which is used to control the displays and indicators in the CID will also be included as an indirect but integral part of the CID system.

### Liquid Crystal Display

The E90 vehicles equipped with a navigation system will have a CID. There is only one version of the CID available:

- LCD 8.8" High in connection with CCC The display is equipped with a digital 8.8" TFT screen (Thin Film Transistor) with a visible area of 209.28 mm x 78.48 mm. The resolution of the TFT display is 400 x 3 x240 pixels.



**Central Information Display (CID)**



## Controller

The controller is the central operating control for all comfort functions and selected options for some vehicle functions that are displayed on the central information display.

The controller is located in the center console immediately behind the gear selector lever, within reach of the user (driver and front passenger).

There is only one variant available:

- High variant with CCC

The tactile feedback for the rotary movement at the controller is generated electrically in the High variant. The tactile feedback for the rest position, the main directions of movement and the depressed position is created by mechanical means.

The principle of the controller is identical to that on the BMW 6 Series, BMW 5 Series, and BMW 7 Series models.

The menu button which can be used to show the main menu in the CID is located directly behind the controller. In addition to the menu button, another button is provided to activate/deactivate the voice recognition system SVS.

The button signals are read into the controller and converted into K-CAN telegrams.



Index	Explanation
1	Controller
2	Button for Main Menu
3	Button for voice input system

## Principles of Operation

The menus for the E90 are the same as those for the E60/63/4.

The controller is the same as the one used on E6x vehicles.



---

## Service Information

### Service Mode

The controller can be used to activate the Service mode functions.

Service mode is a special facility which provides information about the status of the display and user control system.

Service mode can be used, for example, to read out hardware/software statuses for the central information display or control units in the CCC system network.

As an addition to the extensive diagnostics available through the diagnosis system, Service mode acts as a simple means of quickly accessing diagnostic data without the need for a diagnosis tester.

#### ■ Sources of Information

In Service mode, information on the following functions can be selected from the upper menu bar:

- C-Application
- C-HOST
- C-Tuner
- C-ASK
- C-Gateway.

The information available at this time is software, hardware, and operating system status. Further development should come soon.

Push the controller in any direction to return to the main menu.

#### ■ Activating Service Mode

Select main menu and press and hold the controller. Tactile feedback will then be generated.

- Turn controller 3 stops clockwise
- Turn controller 3 stops counter-clockwise
- Turn controller 1 stop clockwise
- Turn controller 1 stop counter-clockwise
- Turn controller 1 stop clockwise
- Press the controller to confirm, Service mode will then appear in the CID.

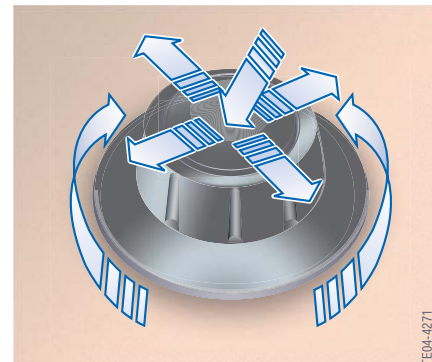

# Connected Service

Connected Service is a maintenance concept that has been part of the BMW Group since the introduction of the BMW 7 Series.

Connected Service is made up of several modules; some of these are already in operation while others have been further developed or introduced for the first time with the launch of the BMW 3 Series.

Connected Service is an indication of how communications and networking between the car and Service are increasing. TeleService1 can even make an automatic service call which informs the customer's home dealer that a service is due.

The Key Reader is an important Connected Service module. Service reception is able to read the data stored in the vehicle key with the Key Reader.



**Connected Service Modules**

## Condition Based Service (CBS)

In the same way as the mid-range and luxury models, the BMW3 Series will also be offering service intervals that are geared towards the current condition of selected components, i.e. servicing that depends on the condition of components and maintenance requirements; this is known as Condition Based Service (CBS).

Condition based service therefore means - servicing on a timely basis.

The system calculates when a service operation, e.g. an oil change is due and informs the customer of this via the liquid crystal display in the instrument cluster.

CBS sorts all the data according to date due and can determine when the vehicle should be taken into service.

If a central information display CID is installed, the instrument cluster passes on the sorted data to the CID where the data can be displayed in the service menu.

There are ten different types of service, with each of these types being assigned to a specific service group, e.g. oil change.

The system comprises the following components with their sensors:

- Instrument cluster
- External control units such as DME, IHKA, and DSC
- Car Access System (CAS) 2
- Central information display CID

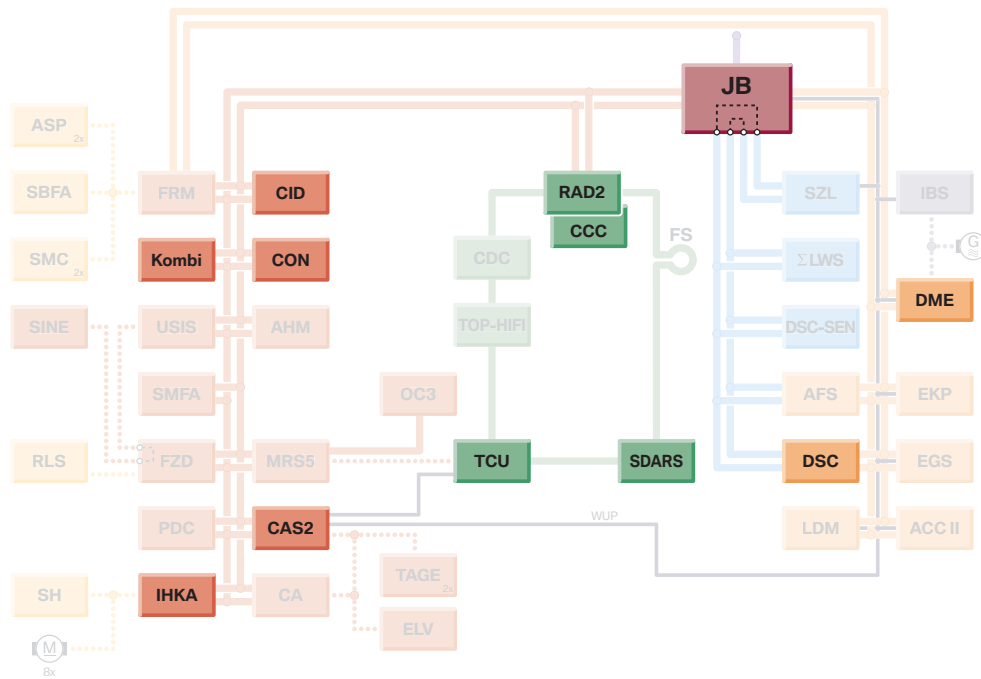

### Control Modules Involved in CBS

## CBS Display- Instrument Cluster

The CBS display always comprises the following two separate displays:

- A colored symbol in the upper display
  - Orange for normal
  - Yellow for service due
  - Red for service overdue
- Information on remaining distance and/or due date in the lower display.

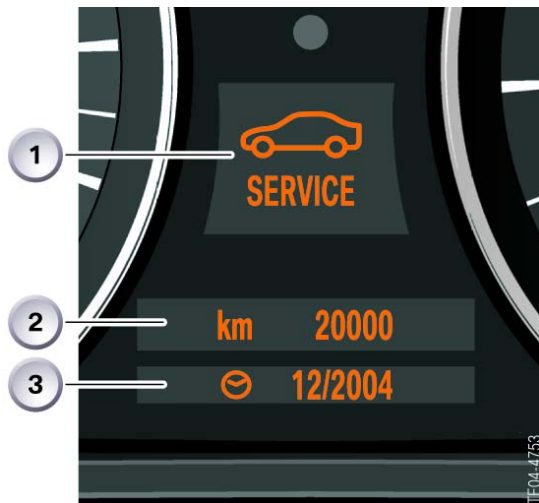

**CBS Display in the Instrument Cluster**

Index	Explanation
1	CBS symbol
2	Remaining distance display
3	Final date information

## CBS Display - Central Information Display

All information on the individual service operations can be displayed in the CID.

To access the CBS date press the controller, the "Settings" menu will appear.

Turn the controller until "Service" is highlighted, then press to activate the CBS menu.

The following operating and display fields are shown:

- Status bar
- Menu bar 1
- Menu bar 2
- Display field for CBS symbol
- Display field for service operation.



Index	Explanation
1	Menu bar 1 - Service requirement,CC messages - Service
2	Menu bar 2 - Status - There are currently no requirement messages
3	Display field for CBS symbols
4	Status bar
5	Igniter pellet for belt force limiter
6	Display field for service operation
7	Target date

The service operation display field always shows the first five messages.

Any overdue service operations and symbols marked in red in the list are always at the top of the list of messages.

To display the information concerning a specific service operation on the CID, turn the controller to select the required service operation and display the selection by pressing the controller.

The following display appears in the CID if, for example, the service operation "§ Vehicle inspection" is selected and activated:



Index	Explanation
1	Exit display, return to last setting
2	Date for general inspection
3	Text field for further information
4	Schedule date for service

Once the service date has been set and confirmed by pressing the controller, the priority of the service operation changes, e.g. from red to green and the service operation is sorted in the list.



---

## Service Information

### Resetting the Service Operations

When one or more service operations have been carried out, e.g. front brake pads have been changed, these operations must be reset to their full service interval.

There are three options for resetting the service operations:

1. Legally required service operations such as the vehicle inspection (HU) and exhaust emission inspection (AU) can only be reset in the "Service" menu.
2. All vehicle servicing service functions such as changing spark plugs are reset via the reset button for the trip distance recorder in the instrument cluster. If the reset button is pressed for longer than ten seconds, the reset mode opens automatically.
3. All fields can be reset using the service functions found in the diagnosis program of the DISplus or GT1.

To reset the service information data using the cluster:

- KL-15 on and all Variable displays in cluster off (clock should be displayed)
- Press and hold odometer reset button until CBS pictures display in cluster for about 5 seconds then release
- Use the BC button to scroll through till desired resetable picture is displayed.
- "Reset?" is displayed, Press and hold BC button a picture of a small analog clock runs through its display. When complete, the CBS reset that you chose is reset.
- If you want to insure that the reset was done, you can press the BC button while still looking at the CBS reset pictogram and the acknowledgment of reset will be shown with a check mark in a box

### Entering Due Date

The due date for the legally required general inspection and exhaust emission inspection can be entered only in the central information display with the aid of the controller.

Since different laws are applicable depending on the country, country-specific intervals can be found at this point. For markets where no such regulation applies for general inspection and exhaust test, this function can be suppressed by the diagnostic software in the DISplus or GT1 under: service functions -handover inspection.

Carry out the following procedure to enter the due date:

- Select "Service" from the "Settings" menu and confirm
- Select service operation "§ Vehicle inspection" for example and confirm. "Set service date" is marked.
- Press controller to activate the input box.
- Enter the date by turning and pressing the controller.
- Select "Exit display" and confirm to return to the last setting.

## Entering Due Date



Index	Explanation
1	Exit display, return to last setting
2	Date for statutory vehicle inspection
3	Text field for further information
4	Activate deadline in (2)